

Isometric View

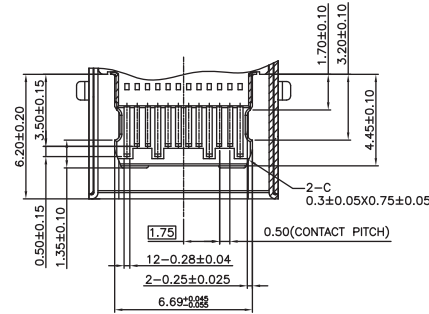

Section B-B

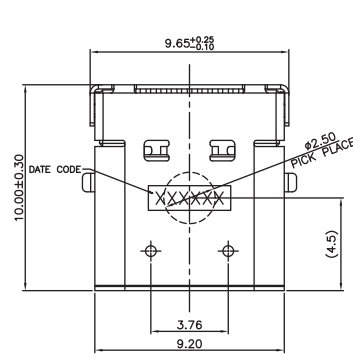
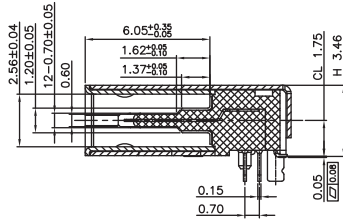

Section A-A

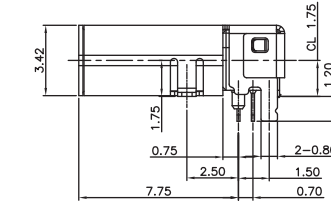
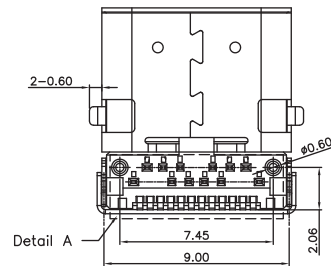
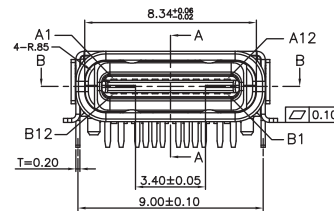

Detail A

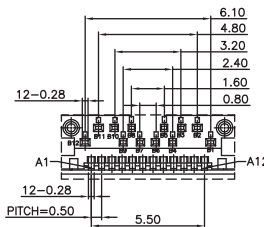

Pin	Signal Name	Mating Sequence	Pin	Signal Name	Mating Sequence
A1	GND	First	B12	GND	First
A2	SSTXp1	Second	B11	SSRXp1	Second
A3	SSTXn1	Second	B10	SSRXn1	Second
A4	VBUS	First	B9	VBUS	First
A5	CC1	Second	B8	SBU2	Second
A6	Dp1	Second	B7	Dn2	Second
A7	Dn1	Second	B6	Dp2	Second
A8	SBU1	Second	B5	CC2	Second
A9	VBUS	First	B4	VBUS	First
A10	SSRXn2	Second	B3	SSTXn2	Second
A11	SSTXp2	Second	B2	SSTXp2	Second
A12	GND	First	B1	GND	First
SHELL	GND		SHELL	GND	

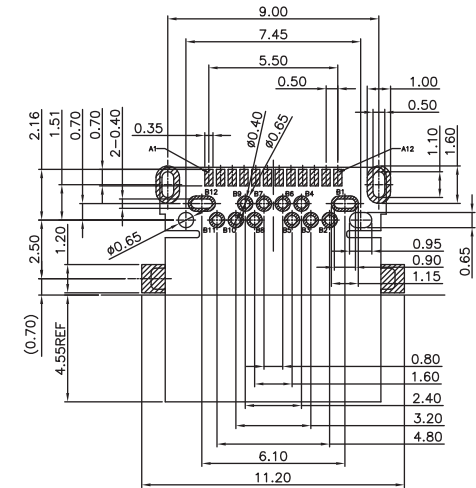

Recommended PCB Layout

ELECTRICAL:

CURRENT RATING: 5A Min. for VBUS,
0.25A Min. for Other

CONTACT RESISTANCE:

< 20 Milliohm Max.

INSULATION RESISTANCE:

> 1000 Mgeaohm Min.

DIELECTRIC WITHSTANDING VOLTAGE:

100 VAC for 1 Minute

MATERIAL:

INSULATOR: LCP, UL94V-0, Black / Blue

CONTACTS: Copper Alloy

CONTACT PLATING:

Gold Plating over 50u" Nickel on Contact Area,
80u" Tin/ Plating over 50u" Nickel on Solder Area

SHELL: Stainless Steel with 50u" Nickel Plating

Mechanical:

INSERTION FORCE: 5 ~ 20N Max.

WITHDRAWAL FORCE: 8 ~ 20N Kg

DURABILITY: 10000 Cycles

HOW TO ORDER:

U X 0 5 - 0 3 0 6 - 0 0 X X - Z

BODY STYLE

0 - Female Right Angle

OF POSITIONS

03 - 24 Position Combo
SMT & Thru Hole

MOUNTING STYLE

06 - Combo Thru Hole & SMT
Thru Hole (Back)
SMT (Front) Shell Legs

CONTACT AREA PLATING

0 - 4u" Au
1 - 7u" Au
2 - 10u" Au
3 - 15u" Au
4 - 30u" Au

PACKAGING

0 - Tray
2 - Tape & Reel

RoHS COMPLIANT

Insulator Color

0 - Black
1 - Blue

Rev	Drawn	Checked	Approved	Date	
0	Issued	B.S.	S.M.	S.M.	07/29/15

SMP TECHNOLOGY, INC.

USB 3.1 Receptacle, Type C Combo Thru Hole & Surface Mount Contacts,
Thru Hole (Back) SMT (Front) Shell Legs

SCALE :N/A

TOL. DEC. .X +/- 0.25 .XX +/- 0.20

ANGLE +/- 5°

UNIT: mm

SERIES: UX05-0306-00XX-Z

Pg: 1