

# of Circuits	A	B	C	# of Circuits	A	B	C
4	3.00	5.10	10.50	23	22.00	24.10	29.50
5	4.00	6.10	11.50	24	23.00	25.10	30.50
6	5.00	7.10	12.50	25	24.00	26.10	31.50
7	6.00	8.10	13.50	26	25.00	27.10	32.50
8	7.00	9.10	14.50	27	26.00	28.10	33.50
9	8.00	10.10	15.50	28	27.00	29.10	34.50
10	9.00	11.10	16.50	29	28.00	30.10	35.50
11	10.00	12.10	17.50	30	29.00	31.10	36.50
12	11.00	13.10	18.50	31	30.00	32.10	37.50
13	12.00	14.10	19.50	32	31.00	33.10	38.50
14	13.00	15.10	20.50	33	32.00	34.10	39.50
15	14.00	16.10	21.50	34	33.00	35.10	40.50
16	15.00	17.10	22.50	35	34.00	36.10	41.50
17	16.00	18.10	23.50	36	35.00	37.10	42.50
18	17.00	19.10	24.50	37	36.00	38.10	43.50
19	18.00	20.10	24.50	38	37.00	39.10	44.50
20	19.00	21.10	26.50	39	38.00	40.10	45.50
21	20.00	22.10	27.50	40	39.00	41.10	46.50
22	21.00	23.10	28.50				

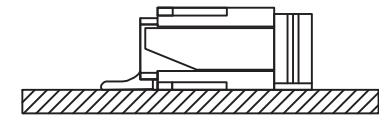

Assembly Layout

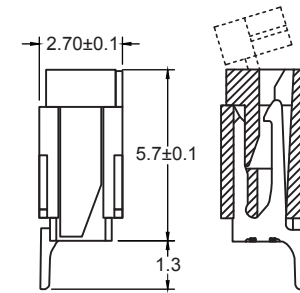
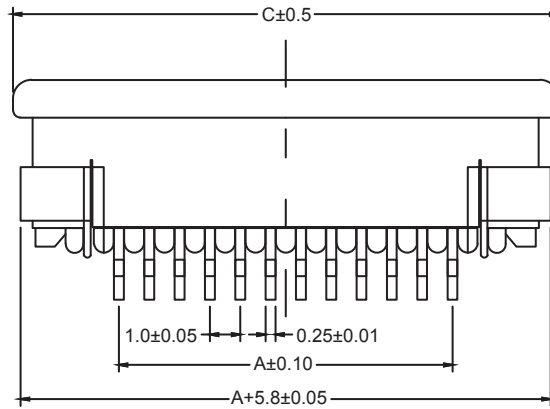
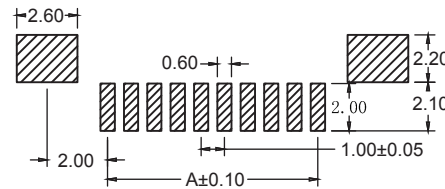

Recommended PCB Layout

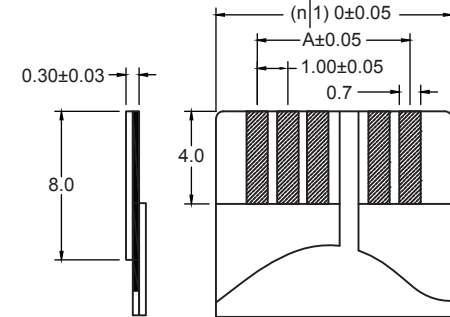

Proper Cable

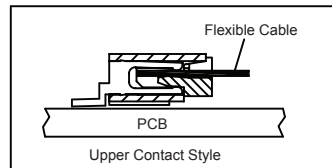

Upper Contact Style

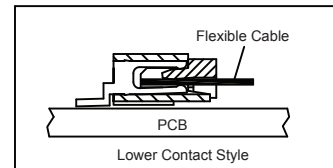

Lower Contact Style

ELECTRICAL:

CURRENT RATING: 0.5A
 VOLTAGE RATING: 50 VDC
 CONTACT RESISTANCE: 30mΩ max. (at 20 mVDC, 100mA max.)
 INSULATOR RESISTANCE: 100MW min. (at 500 VDC)
 DIELECTRIC WITHSTANDING VOLTAGE: AC 250V / 60sec.
 OPERATING TEMPERATURE: -30°C to +85°C

MATERIAL:

HOUSING: LCP UL94V-0
 SLIDER: LCP: Color - White
 CONTACT PLATING: Tin (120m") MIN. over Nickel (50m") MIN.

HOW TO ORDER:

F 2 1 3 - X X 2 7 - X 0 X - Z

NUMBER OF CONTACTS:

03 to 30 - SEE TABLE

CONTACT POINT:

3 - UPPER
 4 - LOWER

PACKAGING:

0 - TUBE
 2 - TAPE/REEL

**RoHS
 COMPLIANT**

Rev	Drawn	Checked	Approved	Date
0 Issued	B.S.	S.M.	S.M.	04/15/10

SMP TECHNOLOGY, INC.
 FFC Connector, 1.0 mm Pitch, Side Entry, 2.7 mm Height,
 ZIF, Surface Mount